



**STC-DVIR5 PROWLER**

**User's Manual**



**Toll Free Customer Support 1-877-269-8490**

**[www.stealthcam.net](http://www.stealthcam.net)**

Version 1.0

07/07

STC-DVIR5 PROWLER

**For Customer Service or Warranty Information Call Toll Free**

**877-269-8490**

Stealth Cam, LLC

P.O. Box 539504

Grand Prairie, TX 75053-9504

[www.stealthcam.net](http://www.stealthcam.net)

**Stealth Cam Limited Warranty**

Your Stealth Cam scouting camera is covered by a 90 days Limited Warranty on parts and labor from the date of original purchase, and purchases must be made through an authorized dealer. The warranty covers defects in workmanship and materials. The warranty does not apply to units, which have been damaged or abused intentionally or unintentionally. A purchase from individuals or unauthorized internet sites voids the warranty.

Tampering with or altering the unit will void the warranty. Any unauthorized service will void warranty. Original sales receipt must be produced for any warranty service and a Return Authorization (RA) number must be obtained from customer service at 877-269-8490 prior to returning product.

[www.stealthcam.net](http://www.stealthcam.net) Toll Free 877-269-8490

## Manual Contents

Camera overview	4
Camera kit contents	8
Battery and memory Installation	9
Set up and programming	12
Camera use	20
Mounting the camera	21
Viewing & Deleting images	27
Memory compatibility chart	36
Technical Specs	37
General Information	41
Moon phase chart	43

# STC-DVIR5 PROWLER

## Camera overview

Front housing image with major parts indication.

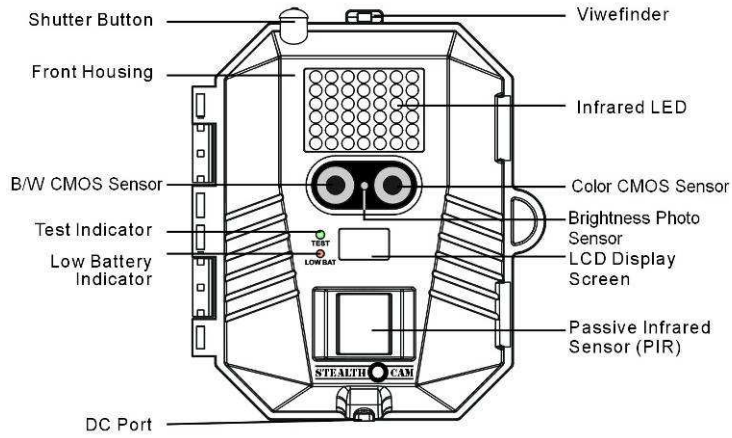

# STC-DVIR5 PROWLER

Open view image with major parts indication

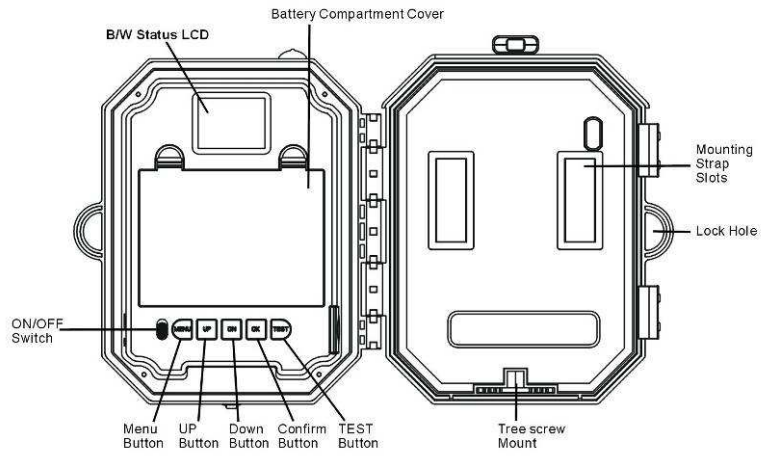

[www.stealthcam.net](http://www.stealthcam.net) Toll Free 877-269-8490

STC-DVIR5 PROWLER

Side view with major parts indication

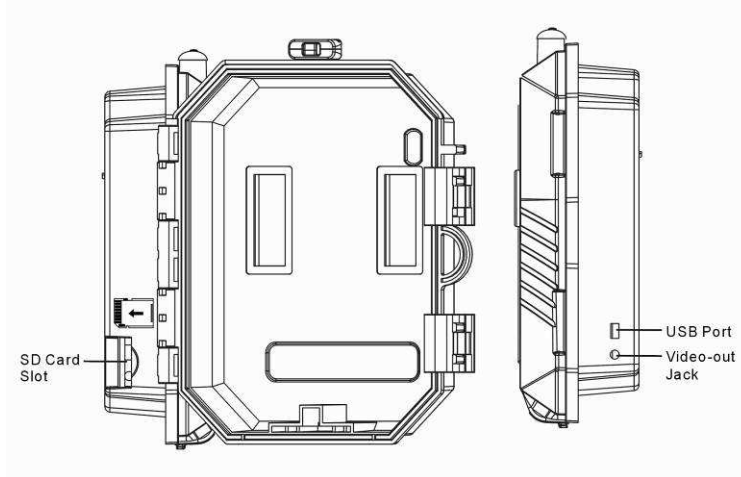

STC-DVIR5 PROWLER

**Picture / Image Capacity**

SD card	High		Low		Base		AVI (in seconds)	
	Color	B&W	Color	B&W	Color	B&W	Color	B&W
16MB	16	53	32	80	80	160	40s	45s
32MB	32	106	64	160	160	320	80s	90s
64MB	64	212	128	320	320	640	160s	180s
128MB	128	424	256	640	640	1280	320s	360s
256MB	256	848	512	1280	1280	2560	640s	720s
512MB	512	1696	1024	2560	2560	5120	1024s	1440s
1 GB	1024	3392	2048	5120	5120	10240	2048s	2880s
2 GB	2048	6784	4096	10240	10240	20480	4096s	5760s

NOTE: Picture / Image Capacity Chart provides approximate number of images or AVI movies based on resolution setting and the size of memory card. These figures may vary depending on the amount of detail in the image.

[www.stealthcam.net](http://www.stealthcam.net) Toll Free 877-269-8490

## STC-DVIR5 PROWLER

### Camera kit contents

- Model STC-DVIR5 PROWLER Digital Scouting Camera
- CDROM (Contains Ulead Photo Explorer 8.0 and camera driver)
- User Manual.
- USB cable.
- TV out cable for TV (RCA Jack).
- TV out cable for handheld TV (Mini Jack).
- Strap.

## Battery & memory installation

**Warning:** Do not use different Voltage lead acid battery other than the one specified in this section. Doing so will damage the camera and will void the warranty.

The Stealth Cam STC-DVIR5 PROWLER Advanced Digital Scouting Camera is designed to operate using two different types of battery power options.

NOTE: Always have camera in the OFF position when installing or removing batteries.

### **Batteries “C” cell**

The internal battery compartment accepts 6 “C” cell batteries. Be sure to use high quality brand name alkaline batteries. Install batteries with correct polarity (+/-) as noted inside the battery compartment.

## STC-DVIR5 PROWLER

### 12V Lead Acid external battery

The STC-DVIR5 PROWLER is equipped with an external power jack designed to accept a barrel plug cable to attach to a sealed lead acid battery. (sold separately). Battery cable and complete 12V Lead Acid battery kits are available wherever Stealth Cam scouting cameras are sold or call toll free 877-269-8490. Only Stealth Cam external battery accessories are recommended.

- Insert the external battery barrel plug into the DC 12V jack on the bottom of camera housing
- Turn the camera power on.
- ❖ ***Please make sure the voltage and polarity (+/-) are correct before connection. Incorrect voltage or polarity (+/-) will damage the camera.***

### Memory Options

Your STC-DVIR5 PROWLER camera is equipped with 32MB built in flash memory. The camera is also equipped with an expandable media card slot capable of accepting up to 2GB SD card (sold separately). With no memory card inserted into the slot,

[www.stealthcam.net](http://www.stealthcam.net) Toll Free 877-269-8490

## STC-DVIR5 PROWLER

the camera will use the built in 32MB memory. If an SD card is inserted into the slot then the camera will bypass the built in memory and utilize the SD memory. The front counter display will show the number of images on the built in memory unless the expansion card is inserted at which point the counter will only show the number of images in the expansion card.

### Inserting SD card

***Make sure camera is in the OFF position whenever adding or removing memory.***

- Insert SD memory card in to the SD card slot completely and in the correct direction as shown by the sticker located at the side of the housing.
- To remove the SD memory card, depress the SD card and pull out the card gently.
- ❖ ***SD cards must be clean (no images from other sources). If you are using the SD card from other cameras, please make sure to format the SD card prior use in the STC-DVIR5 PROWLER. New cards are good to use straight from the package.***

## Set up and Programming

When the camera is first turned on the internal LCD screen displays the camera status. The following information is present on this screen.





- ❖ ***If no buttons are pressed after 30 seconds the LCD screen will power down to conserve battery life and enter 1 minute count down to enter PIR detection mode. To re-power the display screen press and hold the UP or DOWN button for at least 5 seconds.***

**Definition**

- **Time out:** To set the amount of time in minutes the camera will sleep between PIR triggering.
- **Capture mode:**
  - **1P ~ 9P:** 1 to 9 burst mode image capturing per PIR triggering.
  - **Video:** 5 to 90 seconds adjustable video per PIR triggering.
- **Resolution:**
  - ❖ Color Day time
  - **5.0M :** Select this option to capture a 5.0M pixels image. (High image quality)
  - **3.0M :** Select this option to capture a 3.0M pixels image. (Low image quality)
  - **1.3M :** Select this option to capture a 1.3M pixels image. (Base image quality)
  - **Video resolution (640 x 480):** This is the resolution during video capturing.

## STC-DVIR5 PROWLER

- ❖ B&W Night time
  - **2.0M** : Select this option to capture a 2.0M pixels image. (High image quality)
  - **1.3M** : Select this option to capture a 1.3M pixels image. (Low image quality)
  - **0.3M** : Select this option to capture a 0.3M pixels image. (Base image quality)
  - **Video resolution (640 x 480)**: This is the resolution during video capturing.
- **Batteries Status**: It shows the battery status.
  - **Full**: It shows the battery is full. 
  - **Low**: It shows the battery is low and front Low Battery indicator will also blink. 
- ❖ ***When the camera has detected low batteries, (Batteries are lower then 6.0 +/-0.2Volts) the camera unit will power off within 30 seconds automatically. Please replace with new batteries; otherwise the camera will not work properly.***

## STC-DVIR5 PROWLER

- **Day and Time:** It shows the **date and time that you have set.**
- **Moon phase and Temperature:** It shows the moon phase and temperature.

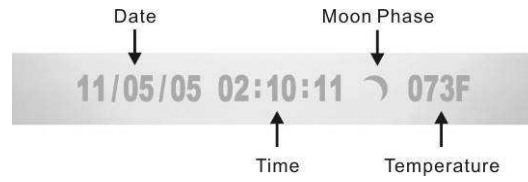

## STC-DVIR5 PROWLER

### **Programming the Stealth Cam STC-DVIR5 PROWLER**

Switch the camera to the ON position. LCD screen will display the camera status screen. Press the MENU button within 30 seconds to enter programming mode.

If MENU button is not pressed within 30 seconds, camera will automatically enter PIR detection mode.

**Set the Resolution:** The first program setting is resolution.

- Press [OK] button to choose the selection
- Press the [UP] or [DN] button to select the desired resolution (HIGH/LOW/BASE) and press [OK] to save and exit to CAPTURING setting

**Set the Capturing sequence. *The Stealth Cam STC-DVIR5 PROWLER can be programmed to shoot 1~9 pictures per triggering.***

- The number of burst mode next to the word CAMERA will be blinking
- Press [OK] button to choose this selection and then press the [UP] or [DN] button to select the desired burst mode setting

[www.stealthcam.net](http://www.stealthcam.net) Toll Free 877-269-8490

## STC-DVIR5 PROWLER

(number of pictures per triggering).

- Press [OK] to confirm your selection and exit to TIME OUT settings.

**Set the Video Mode: *The Stealth Cam STC-DVIR5 PROWLER can be programmed to shoot 5~90 seconds of video per triggering.***

- The video length in seconds will be blinking
- Press [UP] or [DN] button to select the desired video length (from 5 seconds to 90 seconds in 5 seconds increment)
- Press [OK] to save and exit to TIME OUT setting.

**Set the Time out:**

- The time out time will be blinking
- Press [OK] button to choose the selection. Press [UP] or [DN] button to increase or decrease the time value in minutes from 01 to 59 minutes.
- Press [OK] to save the setting and exit to Date & Time setting.

## STC-DVIR5 PROWLER

### **Set Date and Time: This camera uses the 24hr military time format.**

- The date and time digit will be blinking. Press [OK] one more time to enter time setting first.
- Minute digit will be blinking. Press [UP] or [DN] to increase or decrease the minute value (0 – 59)
- Press [OK] to confirm the minute setting and enter hours setting.
- Hour digit will be blinking. Press [UP] or [DN] to increase or decrease the hour value (00 – 23)
- Press [OK] to confirm the hour setting and enter year setting.
- Year digit will be blinking. Press [UP] or [DN] to increase or decrease the year value. Once this is done, press [OK] and enter month setting.
- Month digit will be blinking. Press [UP] or [DN] to increase or decrease the date value. (01 – 12)
- Press [OK] to confirm the month setting and enter date setting.

## STC-DVIR5 PROWLER

- Date digit will be blinking. Press [UP] or [DN] to increase or decrease the date value. (1 – 31) Once this is done, press [OK]. You'll see the word {No-dL} blink. Now press [MENU] to exit program setting and back to status screen.

## STC-DVIR5 PROWLER

### Using the camera

Once all program setting has been completed your Stealth Cam is ready for field use.

### Getting started

It is recommended that you mount the camera 4-5 ft off the ground with the camera pointed at a slight downward angle. Be sure to avoid mounting the camera facing east or west as the rising and setting of the sun could produce false triggers and overexposed images. Clear all branches and other debris away from the front of the camera so as not to block the camera lens or PIR sensor.

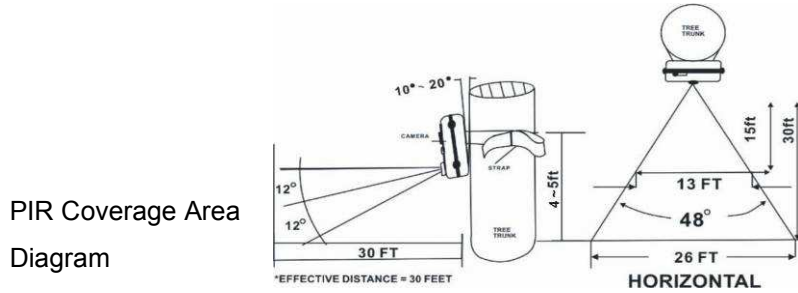

[www.stealthcam.net](http://www.stealthcam.net) Toll Free 877-269-8490

## Mounting the camera

Mounting the camera with Tree Screw (Optional Accessory sold separately)

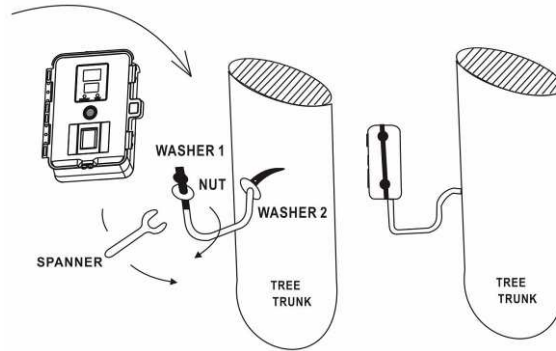

- Hand twists the screw into the tree or post at the desired position.
- Attached the camera to the screw by turning the camera onto the mounting screw to the desired position.
- Tighten the stabilizer nut.

[www.stealthcam.net](http://www.stealthcam.net) Toll Free 877-269-8490

## STC-DVIR5 PROWLER

- ❖ **Attached camera to tree screw. Do not over tighten as this may cause damage to camera housing. Using the nut and washer that came with the tree screw, tighten to the bottom of camera for greater stability.**

### Mounting the camera with the supplied strap

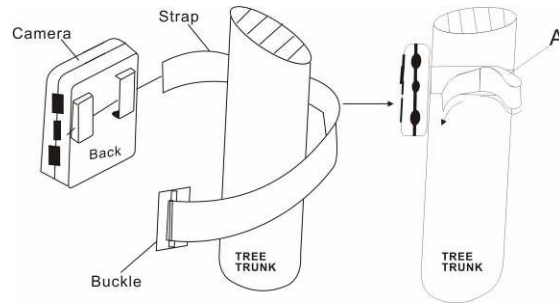

- Insert the strap through the strap slots on the rear housing.
- Wrap the strap around the mounting surface. Secure the strap and tighten the buckle in order to secure the camera.

## STC-DVIR5 PROWLER

***Stealth Cam offers a Security Lock Bracket for uses exclusively with this camera. See included accessory card or call toll free 877-269-8490.***

- ❖ ***In order to obtain proper weather resistance, please make sure that both door latches are securely locked in place.***

### **Testing the camera coverage area**

One of STC-DVIR5 PROWLER Cam's many features is the ability to test the coverage area.

- After mounting the camera, open front housing and slide the power to ON.
- After the front LCD screen has powered on. Press the [TEST] button (this must be done with in 30 seconds or the camera will enter count down mode)
- Close the front housing.
- Walk around in the front of the camera to see if you have mounted the camera in the proper position. A green indicator

[www.stealthcam.net](http://www.stealthcam.net) Toll Free 877-269-8490

## STC-DVIR5 PROWLER

LED light on the front will blink when you have intruded the coverage area.

- Adjust the camera position as needed and repeat testing until the desired coverage area is achieved.
- When you have completed testing the coverage area, there are 2 methods to exit the test mode:
  - a. Option 1: Open the front housing and press the [TEST] button to exit test mode. The camera will then enter count down mode for 1 minute and the front green indicator will start blinking, giving you 1 minute to leave the coverage area. The camera will then enter PIR detection mode.
  - b. Option 2: As a safety precaution, if for any reason you left the area and forgot to push the test button to exit the test mode as shown in option 1 above, the camera will automatically enter the 1 minute count down mode after it is left in test mode for 5 minutes. Camera will then enter PIR detection mode.

**Using the camera in PIR detection mode**

- Mount the camera to tree or other sturdy object using either a tree screw (optional accessory) or supplied mounting strap (You may refer to the mounting suggestions section in this manual)
- Open the front housing and move the switch to the ON position. At this point you have 30 seconds to make any program adjustments.
- After 30 seconds the camera's green LED light will begin blinking and enter count down mode. This is your indication to leave the coverage area within one minute.
- After one minute the camera will enter either image burst mode or adjustable video mode based on your program setting. The camera will then time out between 1 ~ 59 minutes, also based on your setting.
- ❖ ***The time between motion detection and the camera taking the pictures may vary due to lighting conditions, charging of the flash, program setting and battery power level.***

STC-DVIR5 PROWLER

- ❖ *The IR LED will only activate in low light conditions.*
- ❖ *When using the AVI function, Time/Date stamp will not appear on the AVI video clips.*

## Viewing and deleting the images

The STC-DVIR5 PROWLER cam offers the user different options for viewing the images. The external LCD display on the front of the housing will show the number of images in memory.

To wake the camera from PIR detection mode, press and hold either the [UP] or [DN] button for about 5 seconds.

The instructions below are based on starting from a camera that is turned off.

### **Viewing the image on a handheld LCD TV video monitor or your home TV equipped with an RCA input jack (cables included)**

For viewing on handheld LCD TV, attach the appropriate cable to the video out jack on the camera. Insert the other end into the video in jack on handheld LCD TV monitor.

For viewing on home TV, attach the appropriate cable to the video out jack on the camera. Insert the other end into the RCA video in jack on the TV. Make **sure to switch to VIDEO IN mode on your TV. (See your TV owner's manual for directions)**

## STC-DVIR5 PROWLER

Turn on both the camera and TV monitor.

- Your camera is preset to NTSC TV out system by default. If the handheld TV screen does not flicker, then you do not need to set your TV out system. If the handheld TV screen flicker, then you will need to proceed to the next step to set up your TV out to PAL system.
- Press the [MENU] button once. The word {tu-N} on the camera's internal screen will be blinking. Press [OK] to choose this selection.



- Press [DN] button to select TV out in PAL System (which is use in most European and Asian countries). The word {tu – P} will be blinking Press [OK] to confirm this setting.
- Press [MENU] to exit and continue with your image viewing. It will display the last image stored in memory.
- You will see thumbnail images. At this point you may use the [UP] or [DN] button to navigate though your thumbnail images.

## STC-DVIR5 PROWLER

- On the upper left hand corner of your TV monitor, it will either display the picture icon or video icon to show you whether that image is a still image or video clip.
- To view image in full screen, press [OK] button. Press [OK] button again will return to the thumbnail view from the full size image.

### **View AVI Clip on hand held TV monitor or home TV**

- Follow the cable attaching instruction listed in previous section.
- Monitor will display a thumbnail image in the memory.
- Press [UP] or [DN] button to choose the AVI clip that you would like to see.
- Press the [OK] button to play back the AVI motion clip.
- To return to thumbnail image selection view, press [OK] button at the end of the AVI clip.

## STC-DVIR5 PROWLER

### Viewing images by computer download

The Stealth Cam STC-DVIR5 PROWLER Digital Scouting Camera is a plug and play USB storage device. This means users of Windows 2000 / ME / and XP operating systems need not install the camera driver. This camera is not MAC compatible. The disc included in this package contains the camera driver for older operating systems as well as Ulead Photo Explorer 8.0 imaging software for image enhancement and manipulation.

### **Attention:**

The software CD-ROM packaged with the camera is designed for PC's only (not MAC compatible). Playing this CD-ROM on a stereo or CD player may cause damage to it.

### Software installation

- Unplug the USB cable from your camera if you have it plugged in.
- Insert the CD-ROM in CD drive of your PC.
- The auto-run program will execute.
- Follow the instructions shown on screen from your PC to  
[www.stealthcam.net](http://www.stealthcam.net) Toll Free 877-269-8490

## STC-DVIR5 PROWLER

completely install the driver and application program.

- Restart windows.
- Successful installation will create “Ulead Photo Explorer” icon on you desktop.
- Connect your camera to the PC by the USB cable, the PC will recognize the new device and set up the configuration of the PC automatically.

***NOTE: Users of Windows 98 or earlier must install camera driver prior to connecting the USB cable.***

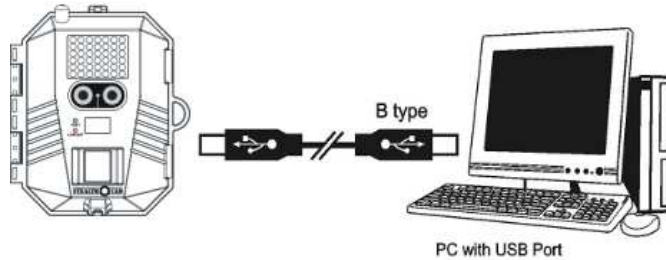

## STC-DVIR5 PROWLER

- If your computer doesn't run automatically, please click "Start" button and choose "Run", and then browse the CD drive and click "Setup".
- Operation manual of Ulead Photo Explorer is contained on the provided CDROM.

### **Viewing the images on your computer using the provided software**

Please refer to Installation section on above to install the software and application program properly.

- Slide the power switch to OFF location.
- To view the images simply plug one end of the USB cable into an available USB port on your computer.
- Plug the other end of USB cable into the camera. The camera will automatically power ON and display the word {USb} on the LCD screen.



## STC-DVIR5 PROWLER

- At the same time, your computer will recognize the camera as a mass storage device and will be found under MY COMPUTER.

### Deleting images

At any time while viewing images on Handheld TV or Home TV you may delete images one at a time or all at once.

- While viewing images in either thumbnail view or full screen press [MENU] once and [UP] button once to enter delete mode. The word {NO-dL} will be blinking.
  - ❖ ***Please note, you can not enter delete mode while the video clip is playing. You must wait until the end of the video clip or while it is in thumbnail view.***
- Press [OK] button to enter the DELETE & FORMAT menu.
- Using the [UP] and [DN] buttons to select the desired function. No Delete (NO-dL), Delete one (d-ONE), Delete ALL (d-ALL), or FORMAT.

## STC-DVIR5 PROWLER



- Press [OK] to confirm your selection.
- Press [UP] or [DN] until you see (NO-dL) and then press [MENU] to return to image viewing.
- If you choose to delete one picture at a time, (d-ONE), it will delete the picture that you selected on the thumbnail view or the image that is on full screen.
- If you choose to delete all images (d-ALL), it will delete all images. Once images are deleted from the memory, you will return to status screen.
- If you choose to format your memory, it will erase all images. This feature is particularly useful if you don't want to look through the images one at a time. Once this is done press [DN] button and scroll through the options until you see No Delete (NO-dL), press [OK] and then press [MENU]. This will return to status screen.

STC-DVIR5 PROWLER

**At the end of each program set up selection, you may press [MENU] to exit and return to camera status ready for the 1 minute count down mode to enter PIR capturing.**

## STC-DVIR5 PROWLER

### SD Memory Card Compatibility Chart

The following cards have been tested and approved for use in the STC-DVIR5 PROWLER model.

PQI	32MB, 64MB, 128MB, 256MB, 512MB
San Disk	32MB, 64MB, 128MB, 512MB, 1GB, 2GB
Panasonic	32MB, 64MB, 256MB, 512MB
Toshiba	32MB, 64MB, 128MB, 256MB, 512MB
King Mate	32MB, 64MB, 128MB, 256MB, 512MB
Lexar	32MB, 512MB
Kingston	128MB, 256MB, 512MB
Kodak	128MB, 256MB, 512MB
Dan-Elec	128MB, 256MB, 512MB
PNY	128MB, 256MB, 512MB, 2GB

Proper camera operation cannot be guaranteed when using memory card **NOT** listed above.

## Technical Specifications

### System Requirements and Compatibility

- Windows 98/98se/2000/Me/XP.
  - P 450MHz or equivalent processor.
  - 128MB SDRAM or above.
  - VGA Video Card with 32MB RAM for minimum, Color 16 bit or higher.
  - An available CDROM driver and an available USB Port.
  - 600 MB free hard disc space.
  - Optional: Windows compatible sound card, Microphone and speaker.
- ❖ ***If you have any questions regarding your PC specifications please call your PC manufacturer.***

## STC-DVIR5 PROWLER

### Camera Features and Specification.

- Image sensor 1: 1.3 CMOS Color sensor
- Camera lens 1 4P glass lens with IR coating
- Image sensor 2: 3.0 CMOS Color sensor
- Camera lens 2: 5P glass lens with IR coating
- Built in 2.0" B&W LCD display.
- Built in 32M flash memories for image storage.
- External memory support: SD memory card up to 2.0 GB.
- Resolution Options: 5.0M, 3.0M, 1.3M for color
- Resolution Options: 2.0M, 1.3M, 0.3M for B&W
- Capturing Options: 1 to 9 image burst mode or AVI.
- Image performance for video stream: 12fps in 640 x 480 pixels.
- Auto white balance and auto expose.
- Auto IR emitter light control

## STC-DVIR5 PROWLER

- ❖ Effective Range for Still picture (up to 50 ft)
- ❖ Effective Range for AVI clip (up to 50 ft)
- Real time clock for date and time stamping.
- 4 digits LCD Image counter.
- Battery low LED indicator.
- Green Test LED indicator
- TV out support for NTSC and PAL system.
- Focusing: 5 ft to Infinity
- Effective viewing Angle: 52 deg
- PIR detection angle 48 deg
- Low power consumption:
  - Standby current: < 2mA.
  - Capture current <180mA
- Interface type: USB 1.1.
- Power: C size alkaline Batteries x 6

## STC-DVIR5 PROWLER

- External power: 12 volts battery pack
- Image format: Standard JPEG or Motion JPEG (AVI)

## General Information

### Storing conditions

- Operating Environment: 14 to 104 deg F (-10 to 40 deg C). 20-85% relative humidity, non-condensing.

### Special care instructions!!

- The camera is designed to be weather resistant. Never attempt to immerse the unit in water or any other liquid. This will damage the unit and void the warranty.
- Use a soft lens cloth for cleaning lens. Avoid touching lens with fingers.
- Remove dirt or stains with a soft cloth dampened with water or neutral detergent. Keep the STC-DVIR5 cam in a dry and cool dust-free environment or container when it is NOT used.
- Take the batteries out, when the STC-DVIR5 cam is NOT to be used over a long period.
- Avoid dropping the STC-DVIR5 cam on to hard ground. Do not disassemble the STC-DVIR5 cam.
- Do not mix new and old batteries.
- Do not open the camera for unauthorized service. This could

[www.stealthcam.net](http://www.stealthcam.net) Toll Free 877-269-8490

## STC-DVIR5 PROWLER

cause serious damage to the unit and will void the warranty.

This camera is a precision electronic device. Do not attempt to service this camera yourself, as opening or removing covers may expose you to dangerous voltage points or other risks.

US Patents









































6,735,387

6,768,868

6,834,162

7,149,422

**Moon Phase Symbol Chart**

Symbol	Lunation from to		Actual phase				
	1	5					
	6	10					
	11	14					
	15	16					
	17	20					
	21	25					
	26	29 or 30					

Product specifications are subject to change. Stealthcam is not responsible for any photographic or typographical errors.

WF072\_R0 Printed In China

[www.stealthcam.net](http://www.stealthcam.net) Toll Free 877-269-8490